



Informações Gerais

Nome

JAGUAR FIV RG

Série/RGD

RGM 5081

Nasc

21/01/2018

PROP

FAZENDA SÃO BENEDITO / RICARDO DE ANDRADE GOUVEIA / GOYA AGROPECUÁRIA E COMÉRCIO LTDA EPP

Pedigree

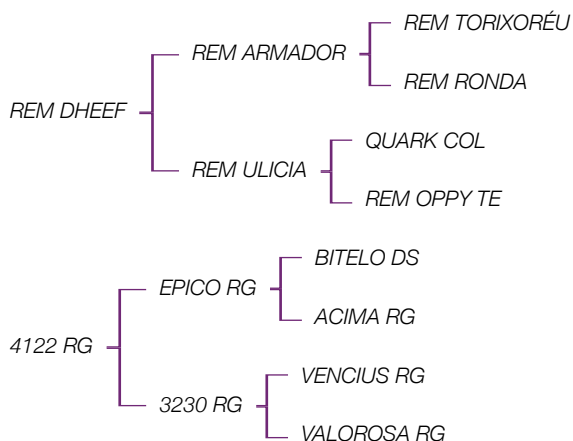



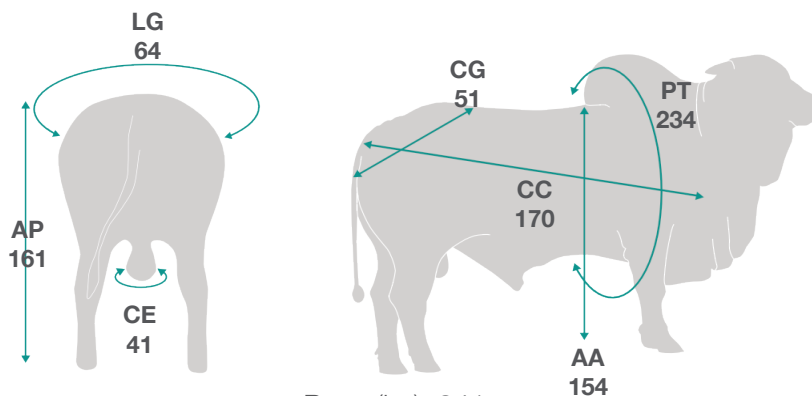















Medidas



PROGÊNIE			
NF120			0
NR120			0
NF450			0
NR450			0
ÍNDICE		DEP	AC (%)
MGTe	TOP 1%	25,62	70
PRODUÇÃO			
PN	TOP 97%	1,92	81
P120	TOP 0.1%	12,39	66
P210	TOP 0.1%	19,70	69
P365	TOP 0.1%	31,93	75
P450	TOP 0.5%	31,55	77
PE365	TOP 30%	0,27	80
PE450	TOP 34%	0,27	83
MATERNAL		DEP	AC (%)
MP120	TOP 86%	-0,46	58
MP210	TOP 84%	-0,54	57
IPP	TOP 12%	-0,84	55
3P	TOP 58%	62,30	72
PG	TOP 10%	-0,63	84
STAY	TOP 5%	80,32	67
PAC	TOP 2%	8,80	59
CARÇAÇA		DEP	AC (%)
AOL	TOP 3%	2,60	77
ACAB	TOP 1%	0,62	75
MARM	TOP 10%	0,08	78

MORFOLÓGICAS		DEP	AC (%)
ED	TOP 0.1%	75	69
PD	TOP 0.1%	75	74
MD	TOP 0.1%	75	72
ES	TOP 0.1%	75	79
PS	TOP 0.1%	75	82
MS	TOP 0.1%	75	81

PROGÊNIE			
FILHOS			0
REBANHOS			0
ÍNDICE		DEP	
IQG	TOP 0.1%	40,98	
PRODUÇÃO			
		DEP	AC (%)
PN	TOP 99%	0,90	40
PD	TOP 0.1%	16,89	45
PS	TOP 0.1%	29,08	47
GPD	TOP 0.1%	12,19	47
PES	TOP 1%	1,26	39
MATERNAL		DEP	AC (%)
P120-EM	TOP 95%	-2,14	35
TM120	TOP 10%	3,05	--
TMD	TOP 2%	6,69	--
IPP	TOP 0.5%	-27,04	28
RD	TOP 97%	-1,47	44
STAY	TOP 5%	34,76	19
CARÇAÇA		DEP	AC (%)
AOL	TOP 2%	2,35	40
EGS	TOP 0.1%	3,07	32
MARM	TOP 29%	0,40	31
MORFOLÓGICAS		DEP	AC (%)
CFD	TOP 0.1%	7,23	32
CFS	TOP 0.1%	8	34

PROGÊNIE			
FILHOS			0
REBANHOS			0
ÍNDICE		DEP	
iABCZ		DECA 1 27,05	
PRODUÇÃO		DEP	AC (%)
PN		DECA 10 0,90	40
PD		DECA 1 16,89	45
PA		DECA 1 24,26	44
PS		DECA 1 29,08	47
GPD		DECA 1 12,19	47
PE365		DECA 1 0,96	37
PE450		DECA 1 1,26	39
MATERNAL		DEP	AC (%)
PM-EM		DECA 10 -2,14	35
TMM		DECA 1 3,05	--
TMD		DECA 1 6,69	--
IPP		DECA 1 -27,04	28
PVD		DECA 10 -1,47	44
STAY		DECA 1 34,76	19
CARÇAÇA		DEP	AC (%)
AOL		DECA 1 2,35	40
ACAB		DECA 1 3,07	32
MARM		DECA 3 0,40	31
MORFOLÓGICAS		DEP	AC (%)
ESOB		DECA 2 2,28	39

PSOB	DECA 1	4,79	39
MSOB	DECA 1	5,56	39