



Informações Gerais

Nome

REAL COL

Série/RGD

COL 25479

CEIP

--

Nasc

23/10/2017

PROP

COLONIAL AGROPECUÁRIA

Pedigree

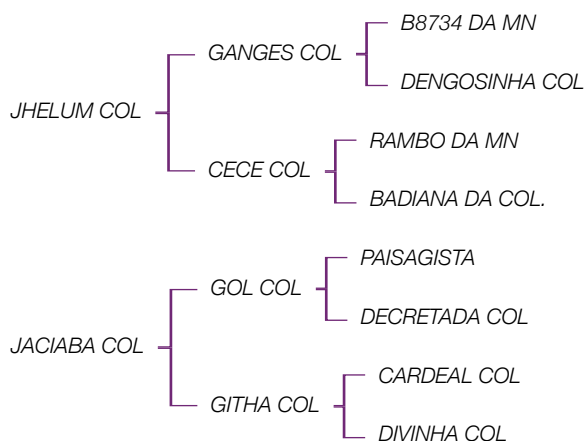

Ultrassom

PESO (kg)	AOL	AOL/100kg	RATIO	MARM	EGS	EGS/100kg	PICANHA
580	78.37	-	-	-	11.7	-	-



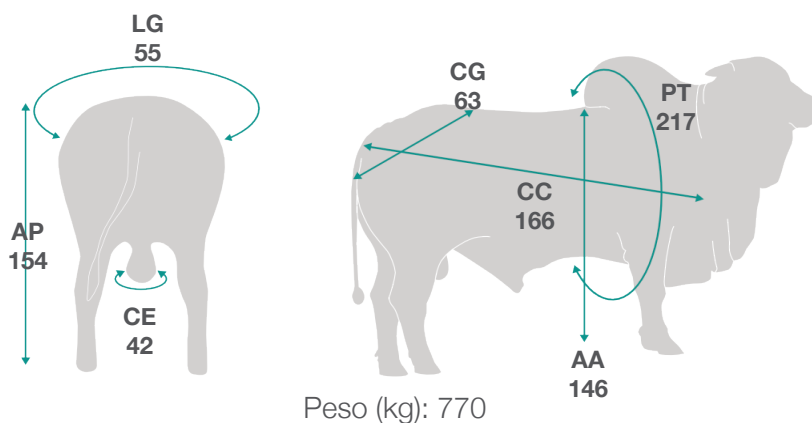













Medidas



PROGÊNIE			
NF120			28
NR120			7
NF450			0
NR450			0
ÍNDICE		DEP	AC (%)
MGTe	TOP 8%	19,53	73
PRODUÇÃO		DEP	AC (%)
PN	TOP 86%	1,35	83
P120	TOP 9%	5,62	70
P210	TOP 6%	10,74	72
P365	TOP 6%	19,96	77
P450	TOP 5%	21,90	79
PE365	TOP 20%	0,50	81
PE450	TOP 20%	0,62	84
IPM	TOP 7%	-0,96	74
PA	TOP 42%	16,56	76
MATERNAL		DEP	AC (%)
MP120	TOP 15%	2,32	60
MP210	TOP 11%	3,47	59
IPP	TOP 38%	-0,55	57
3P	TOP 27%	70,41	74
PG	TOP 46%	0,40	86
STAY	TOP 13%	77,39	69
PAC	TOP 12%	6,40	62
CARCAÇA		DEP	AC (%)
AOL	TOP 20%	0,35	79

ACAB	TOP 4%	0,38	76
MARM	TOP 90%	-0,09	80
MAC	TOP 58%	0,01	69
EFICIÊNCIA ALIMENTAR		DEP	AC (%)
CAR	TOP 67%	0,02	71
IMS	TOP 82%	0,18	76
MORFOLÓGICAS		DEP	AC (%)
ED	TOP 72%	39,08	71
PD	TOP 10%	71,86	76
MD	TOP 7%	73,13	73
ES	TOP 33%	57,42	80
PS	TOP 32%	56,47	83
MS	TOP 17%	65,69	82

PROGÊNIE			
FILHOS			97
REBANHOS			16
ÍNDICE		DEP	
IQG	TOP 5%	19,17	
PRODUÇÃO		DEP	AC (%)
PN	TOP 21%	-0,14	50
PD	TOP 19%	4,22	41
PS	TOP 9%	10,89	32
GPD	TOP 6%	6,66	32
PES	TOP 38%	0,22	30
MATERNAL		DEP	AC (%)
P120-EM	TOP 30%	0,90	21
TM120	TOP 38%	1,15	--
TMD	TOP 11%	4,30	--
IPP	TOP 5%	-18,38	17
RD	TOP 16%	0,61	17
STAY	TOP 0.1%	40,79	15
CARÇAÇA		DEP	AC (%)
AOL	TOP 10%	1,49	28
EGS	TOP 0.5%	2,24	15
MARM	TOP 74%	-0,54	11
MORFOLÓGICAS		DEP	AC (%)
CFD	TOP 0.5%	4,63	18
CFS	TOP 0.5%	5,49	16

PROGÊNIE			
FILHOS			97
REBANHOS			16
ÍNDICE		DEP	
iABCZ		DECA 1	16,98
PRODUÇÃO		DEP	AC (%)
PN		DECA 3	-0,14
PD		DECA 2	4
PA		DECA 1	8,59
PS		DECA 1	10,89
PE365		DECA 3	0,25
PE450		DECA 4	0,22
MATERNAL		DEP	AC (%)
PM-EM		DECA 3	0,90
TMD		DECA 1	4,30
IPP		DECA 1	-18,38
STAY		DECA 1	40,79
CARÇAÇA		DEP	AC (%)
AOL		DECA 1	1,49
ACAB		DECA 1	2,24
MORFOLÓGICAS		DEP	AC (%)
ESOB		DECA 10	-1,06
PSOB		DECA 1	3,04
MSOB		DECA 1	2,94