

TENOR
000NE00667



Informações Gerais

Nome
TENOR DA ELGE

Série/RGD
ELGE 3819

CEIP
--

Nasc
03/08/2015

PROP
FAZENDA ELGE

Pedigree

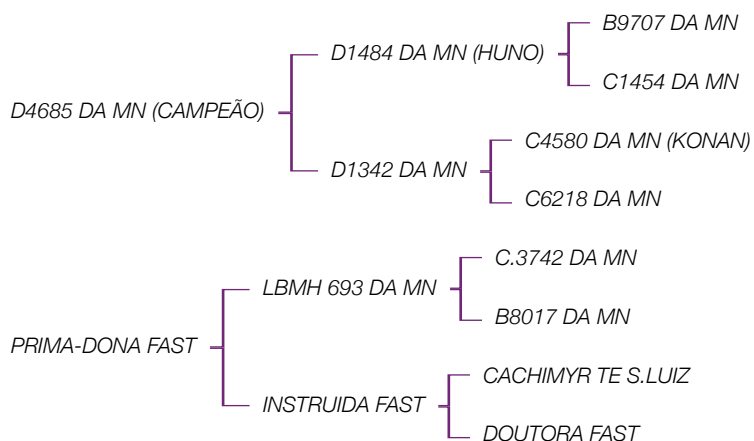







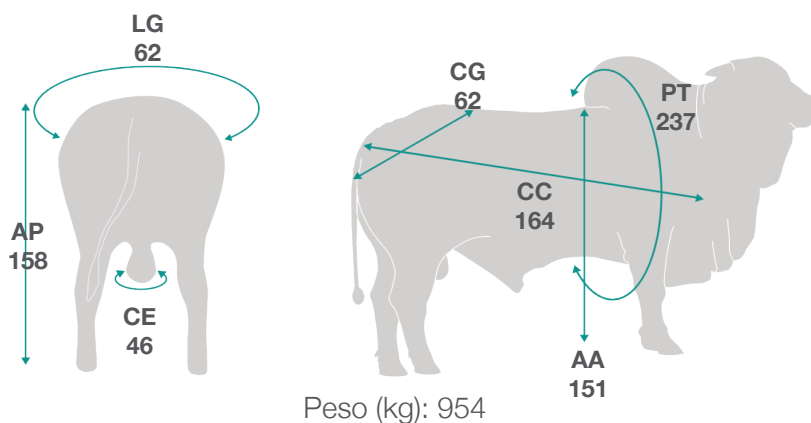









Ultrassom

PESO (kg)	AOL	AOL/100kg	RATIO	MARM	EGS	EGS/100kg	PICANHA
746	130.31	17.47	0.63	3.3	11	1.47	17.13

Medidas



PROGÊNIE			
FILHOS			358
REBANHOS			29
ÍNDICE		DEP	
IQG	TOP 3%	21,24	
PRODUÇÃO			
		DEP	AC (%)
PN	TOP 70%	0,24	74
PD	TOP 15%	4,60	74
PS	TOP 8%	11,07	69
GPD	TOP 6%	6,47	69
PES	TOP 3%	0,97	43
MATERNAL		DEP	AC (%)
P120-EM	TOP 6%	2,31	34
TM120	TOP 5%	3,85	--
TMD	TOP 7%	5,06	--
IPP	TOP 5%	-18,27	28
RD	TOP 6%	1,07	47
STAY	TOP 5%	34,89	24
CARCAÇA		DEP	AC (%)
AOL	TOP 52%	0,09	44
EGS	TOP 0.1%	2,70	32
MARM	TOP 87%	-0,91	32
MORFOLÓGICAS		DEP	AC (%)
CFD	TOP 3%	3,34	46
CFS	TOP 0.5%	5,65	39

PROGÊNIE			
FILHOS			358
REBANHOS			29
ÍNDICE		DEP	
iABCZ		DECA 1	14,99
PRODUÇÃO		DEP	AC (%)
PN		DECA 8	0,24
PD		DECA 2	5
PA		DECA 2	6,02
PS		DECA 1	11,07
PE365		DECA 1	0,86
PE450		DECA 1	0,97
MATERNAL		DEP	AC (%)
PM-EM		DECA 1	2,31
TMD		DECA 1	5,06
IPP		DECA 1	-18,27
STAY		DECA 1	34,89
CARÇAÇA		DEP	AC (%)
AOL		DECA 6	0,09
ACAB		DECA 1	2,70
MORFOLÓGICAS		DEP	AC (%)
ESOB		DECA 5	0,23
PSOB		DECA 1	3,55
MSOB		DECA 1	3,39